

JEXtream[®]

5G Mobile Hotspot

User Manual

Model: RG2100



NOTE: All pictures and drawings shown in this document are for illustration purpose only. Actual product may vary due to product variant and enhancement.

Contents

Getting Started.....	1
<i>Overview</i>	<i>2</i>
<i>Components.....</i>	<i>3</i>
<i>Device Display.....</i>	<i>4</i>
<i>Battery Management</i>	<i>5</i>
Using Your RG2100	6
<i>Accessing the Network.....</i>	<i>7</i>
<i>Using Your RG2100 for the First Time.....</i>	<i>7</i>
System Requirements	7
Installing the SIM Card	7
Charging the Battery.....	8
<i>Connecting to Your RG2100</i>	<i>8</i>
Wi-Fi Name (SSID) and Password	8
Connecting to the Internet.....	8
<i>Using Your RG2100 after Setup is Complete.....</i>	<i>9</i>
Mobile Hotspot to share connections.....	9
Wi-Fi and Web Admin Page Security.....	9
<i>Updating Your RG2100 software</i>	<i>9</i>
RG2100 Settings.....	10
<i>Managing Your Mobile Hotspot.....</i>	<i>11</i>
<i>Web Admin Home</i>	<i>12</i>
<i>Home.....</i>	<i>12</i>
<i>Messages</i>	<i>13</i>
<i>Settings.....</i>	<i>13</i>
Wi-Fi	13
Mobile Network.....	17
Device.....	20
Advanced Router.....	23
<i>About</i>	<i>28</i>
<i>Support.....</i>	<i>29</i>
Troubleshooting	30

<i>Overview</i>	31
<i>First Steps</i>	31
<i>Common Problems and Solutions</i>	31
Regulatory Information	33
<i>Regulatory Statements</i>	34
FCC Equipment Authorization ID: XHG-RG2100.....	34
Body-Worn Operation	34
<i>Safety Hazards</i>	35
Glossary	37
<i>Glossary</i>	38

1

Getting Started

Overview
Components
Device Display
Battery Management

Overview

Thank you for choosing JEXtream® 5G Mobile Hotspot, RG2100!

Having RG2100 at your fingertips will allow you to access the latest 5G and LTE networks for faster uploads and downloads. You can also connect up to 20 Wi-Fi capable devices to the Internet at once - laptops, tablets, eReaders, Smartphones and more.

System Requirements

- Compatible with all IEEE802.11b/g/n/ac/ax Wi-Fi enabled devices.
- Works with the latest versions of most browsers*.

** It is recommended to use the latest versions of Internet browsers. Outdated versions may not be compatible with the RG2100 Web Admin User Interface, <http://mobile.hotspot> or <http://192.168.0.1>*

Components



1. **Power Button** – Turn on/off the device.

Button Operation

	Operations	Actions
	Turn On	Press and hold the button until “Welcome” message appears.
	Turn Off	Press and hold the button until Power-Off animation appears.
	Display Wake-Up	When the display is off, the first quick press of the button wakes up the display.

2. **Display** – Provides general information of the device status and device setting menu.
3. **Power Indicator Light** – White light blinks while the device is powered on.
4. **Navigation Buttons** – Left, Right arrows and Enter button to navigate the device menu.
5. **Type C USB Port** – The USB cable connects here to charge and data transfer.
6. **Vent Holes** – Ventilation holes to cool down the device.
7. **Battery Cover** – Battery is inside the battery cover.
8. **Battery Cover Notch** – Lift the notch to open the battery cover.

Device Display



Status Icon Bar

Icons	Status
	Shows network signal strength.
	Shows network type the device is connected to.
	Appears when the device is roaming on another network.
	Appears when the device is actively sending/receiving data to/from the network.
	Shows the number of connected devices on the Wi-Fi network.
	Shows SIM status (no SIM found, SIM PIN locked, SIM error)
	Appears when the USB port is tethering data.
	Appears when the USB port is connected to an Ethernet adapter.
	Shows the battery status.

Wi-Fi Information: Displays Main and Guest Wi-Fi Network SSIDs and Passwords.

Notification Display: Displays notification and alert messages as available.

Device Menu: Use the navigation buttons to navigate through the device menu icons to see device information or to change device settings.

- 

Data Usage Displays data usage information.
- 

Devices Displays connected device information.
- 

Wi-Fi Displays Wi-Fi network information.
- 

Settings Change device settings.
- 

About Displays device information.

Battery Management

Your RG2100 is equipped with a replaceable and rechargeable battery. It works from its charged battery alone or plugged into a power source.

Note: Please do not attempt to open or disassemble your mobile hotspot and the battery pack. Doing so may cause damage that voids your warranty. Charge the battery with the charger provided together with your mobile hotspot. While the battery is charging, the battery charging icon  displays.

IMPORTANT! Please use only the approved charger to charge your mobile hotspot. Improper handling of the charging port, as well as the use of an incompatible charger may cause damage to your device and void the warranty.

2

Using Your RG2100

Accessing the Network
Using Your RG2100 for the First Time
Connecting to Your RG2100
Using Your RG2100 After Setup is Complete

Accessing the Network

Work effectively outside the home or office with the reliable broadband speed that the 5G and LTE service provides. You can connect to the internet wirelessly at speeds fast enough to keep up to date on all your email correspondence, to download attachments, and to access your corporate intranet and many more.

Using Your RG2100 for the First Time

System Requirements

Your computer, tablet, or other wireless devices need Wi-Fi capability and necessary software such as Internet browsers, email client. Your RG2100 is compatible with most major operating systems and the latest versions of browsers.

Installing the SIM Card

Your SIM (Subscriber Identity Module) card is a small rectangular plastic card that stores important information about your wireless service. If not already inserted, follow the instructions below to install your SIM card.

1. Remove the battery cover by lifting the notch on the cover, then take the battery out.
2. Slide your SIM card into the SIM card slot all the way with Wireless Carrier logo facing up.
3. Properly install the battery and put the battery cover back on.

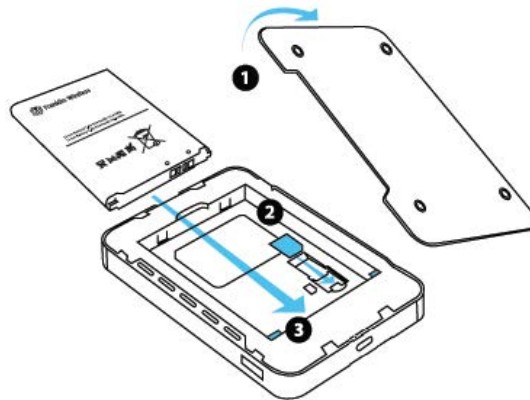

IMPORTANT! Do not bend or scratch your SIM card. Avoid exposing your SIM card to static electricity, water, or dirt. Whenever you insert or remove the SIM card, ensure your RG2100 is powered off and is not connected to any power source. Never use tools, knives, keys, or any type of object to force the door open or to remove the SIM card.

Charging the Battery

Before using your mobile hotspot, ensure that the battery is fully charged. Be sure to use the charger that came with your device.

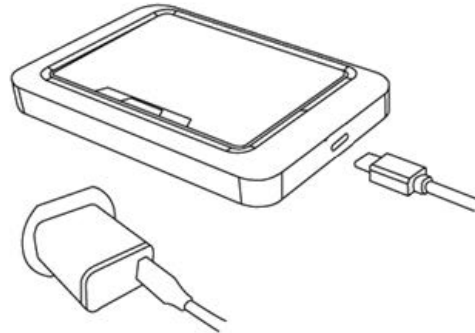

NOTE: Your RG2100 is equipped with a replaceable rechargeable battery. When handling the battery or SIM card, please make sure the device is not connected to any power sources. Do not use any tools, sharp objects or any utensils when dealing with the battery. Doing so may cause damage that voids your warranty.

- It normally takes 3~5 hours, depending on your power sources and device status to fully charge the battery.
- The battery discharges faster as more devices connect to your mobile hotspot.
- Battery life depends on the network, signal strength, temperature, features, and active connection time.
- When charging, keep your device near room temperature.
- Never leave the RG2100 in an unattended vehicle due to uncontrolled temperatures that may be outside the desired temperatures for your device.
- It is normal for batteries to gradually wear down and require longer charging time.

Connecting to Your RG2100

Wi-Fi Name (SSID) and Password

Main and Guest Wi-Fi Names and Passwords display on the device main screen.

Connecting to the Internet

- 1 Open the Wi-Fi application or controls on your laptop or Wi-Fi capable device that you want to connect to your RG2100. Then find your RG2100's Wi-Fi name.
- 2 Click **Connect** and enter the Password when prompted.

Using Your RG2100 after Setup is Complete

Mobile Hotspot to share connections

Your RG2100 is a wireless mobile hotspot creating Wi-Fi local networks that allow up to 20 Wi-Fi connections to the Wi-Fi capable devices around it.

Wi-Fi and Web Admin Page Security

Your RG2100 comes from the factory with security turned on. The default **Web Admin** home page password is 'admin'.

You can create your own **Web Admin** home page password by signing in the **Web Admin** home page. After you create your own **Web Admin** home password, you will be required to use the new password to sign in the **Web Admin** home page.

NOTE: When you sign in the **Web Admin** home page for the first time using the default password 'admin', it will guide you to change the password immediately.

To change your **Web Admin** home page password:

- 1 Connect your Wi-Fi capable device to your RG2100.
- 2 Open an internet browser and open page <http://mobile.hotspot> or <http://192.168.0.1>.
- 3 Click **Settings > Device > Web Interface**.

Updating Your RG2100 software

New software is updated automatically in the following scenarios.

- 1) When a new update is available, your device will download it in the background and wait to be applied on the next power off. When you power off the device, it will be updated automatically before it goes off.
- 2) The device must have at least 40% battery standalone or 20% battery on charger to apply an update.
- 3) If the device continues powered on, it will apply the update between the hours of 2-4am next day automatically and powered back on.

3

RG2100 Settings

Managing Your Mobile Hotspot

Web Admin Home

Messages

Settings

About

Support

Managing Your Mobile Hotspot

Access the RG2100 Mobile Hotspot **Web Admin** home page

You can access your Mobile Hotspot device information and setting pages from your internet browser.

Access RG2100 Mobile Hotspot Web Admin home page.

- 1 Connect your Wi-Fi capable device to your RG2100.
- 2 Open a web browser on your connected device and open the Web Admin home page, <http://mobile.hotspot> or <http://192.168.0.1>.
- 3 Click **Log in** and enter the password. If you entered the correct password, the Web Admin screen appears.

NOTE: The default password is 'admin'. On your first login, you will be directed to 'Change password.'

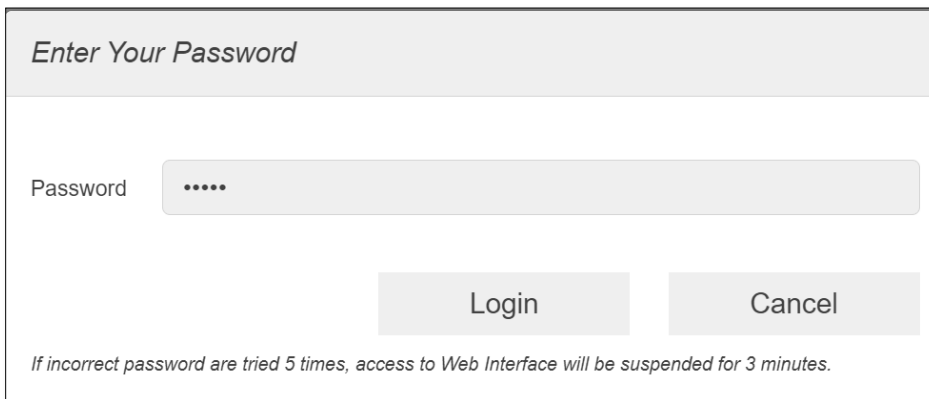

The screenshot shows a login interface with a title bar that reads "Enter Your Password". Below the title bar is a text input field labeled "Password" containing five dots. To the right of the input field are two buttons: "Login" and "Cancel". At the bottom of the form, there is a small line of text: "If incorrect password are tried 5 times, access to Web Interface will be suspended for 3 minutes."

Web Admin Home

The **Web Admin** home page allows you to quickly access all menu options for your RG2100.

- **Home**
- **Messages**
- **Settings**
- **About**
- **Support**

Home

Home menu shows network connection status and data usage information.

- **Disconnect:** Click Disconnect to disconnect the Internet. If Auto Connection is set ON, this button is inactive.
- **Reset:** Reset data usage information.

The screenshot displays the T-Mobile Web Admin interface for an RG2100 Mobile Hotspot. At the top, the T-Mobile logo is on the left, and LTE signal strength, a refresh icon, and a battery icon are on the right. Below the logo, it says "Welcome to your RG2100 Mobile Hotspot" and a "Log out" link. A navigation bar contains icons for Home, Messages, Settings, About, and Support. The main content area is split into two panels: "Connection" and "Data Usage".

Connection Panel:

Network Status	Connected
Network	LTE
Time Connected	1:36:30
Data Used	3.49 MB

Below this table is a "Disconnect" button. Underneath, there are sections for "Main Wi-Fi" (DESKTOP-G180003) and "Guest Wi-Fi" (No Connected Device).

Data Usage Panel:

12.69 GB of 20 GB Used

A green progress bar shows the usage level. A "Reset" button is located to the right of the progress bar. Below the bar, there is a disclaimer: "Data usage calculation is based on the local device usage. Therefore, data usage might be different from billing system provided by the operator. You can reset usage or change usage meter from settings page."

©2021 Franklin Wireless Corp. All Rights Reserved.

Messages

Messages page displays SMS messages sent to your device by your service provider.

Click on the message to see the full message content.

The green dots on the trash bin icon tell you the message is new and not been read.

To delete a selected message, click the trash bin icon.

To delete all messages, click **Delete All** button.

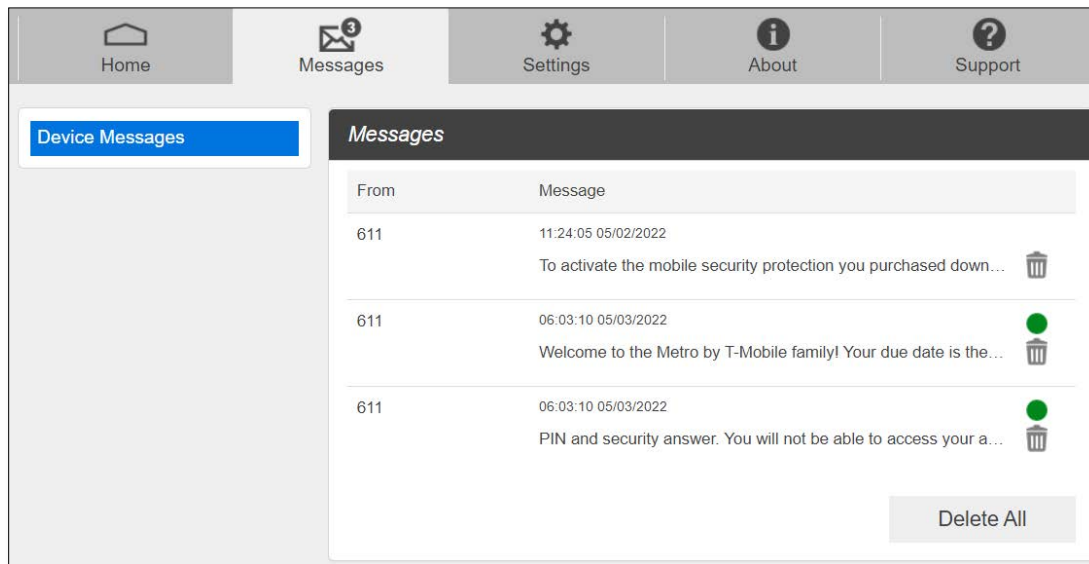

Settings

The **Settings** page has the following menu options.

- **Wi-Fi**
- **Mobile Network**
- **Device**
- **Advanced Router**

Wi-Fi

The **Wi-Fi** menu contains the following options:

- **Basic:** You can change basic Wi-Fi network settings.

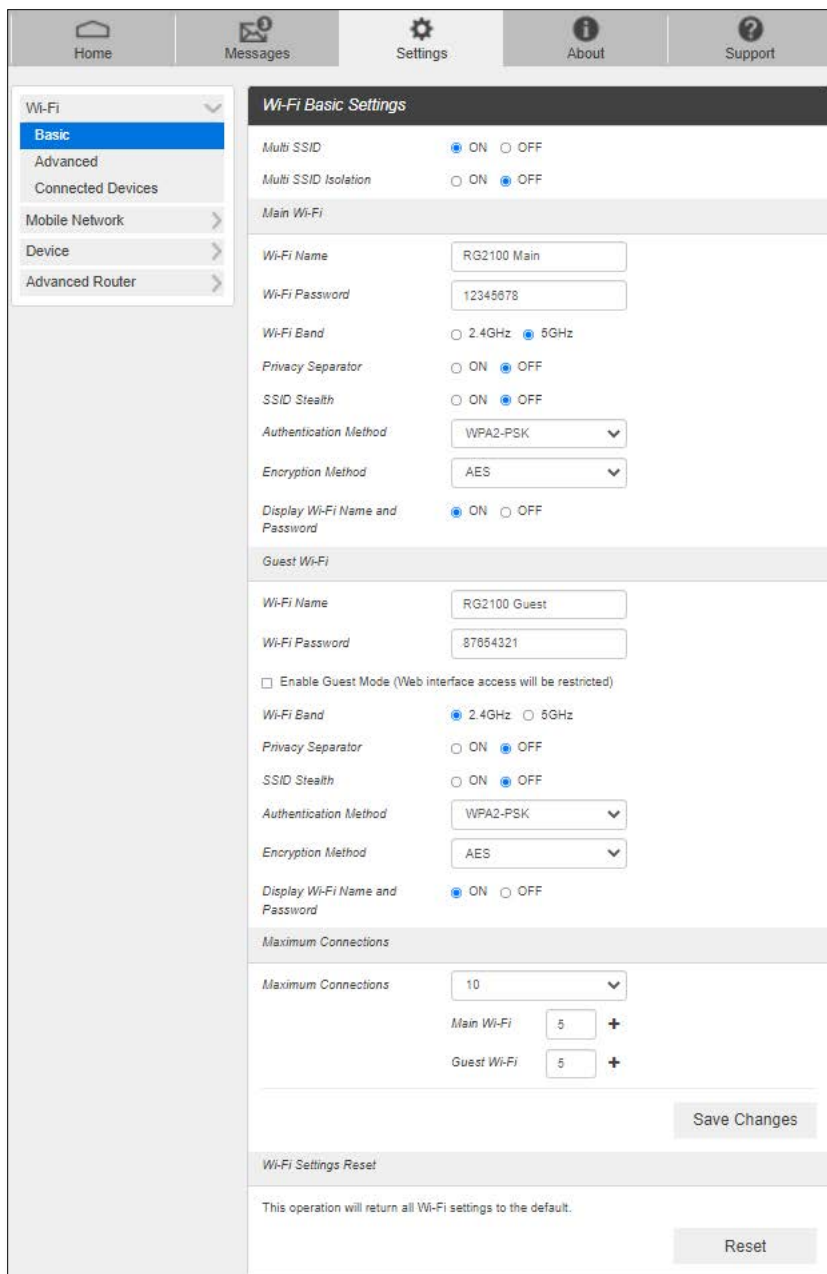

- Multi SSID: Select **ON** if you like to set up a separate guest Wi-Fi network.
- Guest Wi-Fi: If Multi SSID is **ON**, Guest Wi-Fi menu appears. You can change Guest Wi-Fi settings.
- Multi SSID Isolation: If **ON** is selected, it prevents your devices from communicating across the Main and Guest Wi-Fi networks.
- Enable Guest Mode: If the box is checked, users on the Guest Wi-Fi is not allowed to access the **Web Admin** home page, <http://mobile.hotspot>.
- Wi-Fi Name: Wi-Fi Service Set Identifier (SSID).
- Wi-Fi Password: The password needs to be at least 8 characters long.
- Wi-Fi Band: Select 2.4GHz or 5GHz band of Wi-Fi spectrum.

- **Privacy Separator:** If **ON** is selected, your devices on the same Wi-Fi Name cannot make Local Area Network communication.

NOTE: if you connect WLAN printer to your RG2100, Privacy Separator should be OFF for your connected devices to send files to the printer.

- **SSID Stealth:** If **ON** is selected, the Wi-Fi name will not be broadcasted. You need to manually enter the Wi-Fi name to connect.
- **Authentication Method:** Wi-Fi authentication method can be selected.

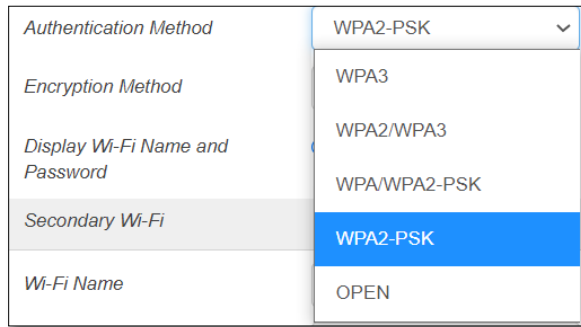

Mode	Description
WPA3	WPA3 is the latest, updated implementation of WPA2
WPA2/WPA3	Apply both the WPA2 and WPA3 scheme.
WPA/WPA2-PSK	Apply both the WPA-PSK and WPA2-PSK scheme.
WPA2-PSK	WPA-PSK is the securer version of WPA with implementation of the 802.11i standard.
OPEN	Authentication and encryption will not be performed. There are risks that private info will be intercepted or network will be used by unauthorized individuals.

- **Encryption Method:** Select an encryption method from the drop-down list.
- **Display Wi-Fi Name and Password:** Select **OFF** to remove the Wi-Fi Name and Password display on your RG2100 device main screen.
- **Maximum Connections:** Choose the maximum number of the devices which connect to your mobile hotspot simultaneously.
- **Wi-Fi Settings Reset:** Click the **Reset** button to reset all Wi-Fi settings to the factory default.

- **Advanced**

These advanced settings should only be changed for specific circumstances. Changes to the advanced settings could result in loss of Wi-Fi connection to your devices. Consult your devices' user manuals for Wi-Fi specifications.

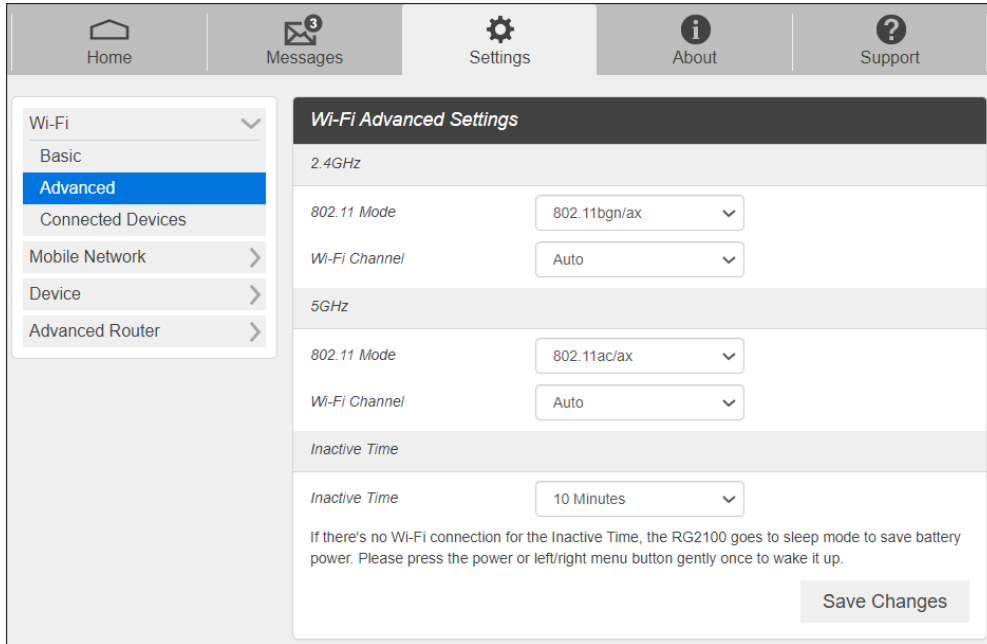

- **802.11 Mode:** Select 802.11 mode from the drop-down list.
- **Wi-Fi Channel:** Select a Wi-Fi channel from the drop-down list.
- **Inactive time:** if there is no Wi-Fi connection for inactive time set here, the device goes to sleep mode to save battery power.

NOTE: Default Inactive Time is 10 minutes. If there is no Wi-Fi connection to your RG2100 for more than 10 minutes, it goes to sleep mode. It is required to press the power button or navigation buttons gently once to wake up your RG2100 to resume.

- **Connected Devices**

The Connected Devices menu contains the following options:

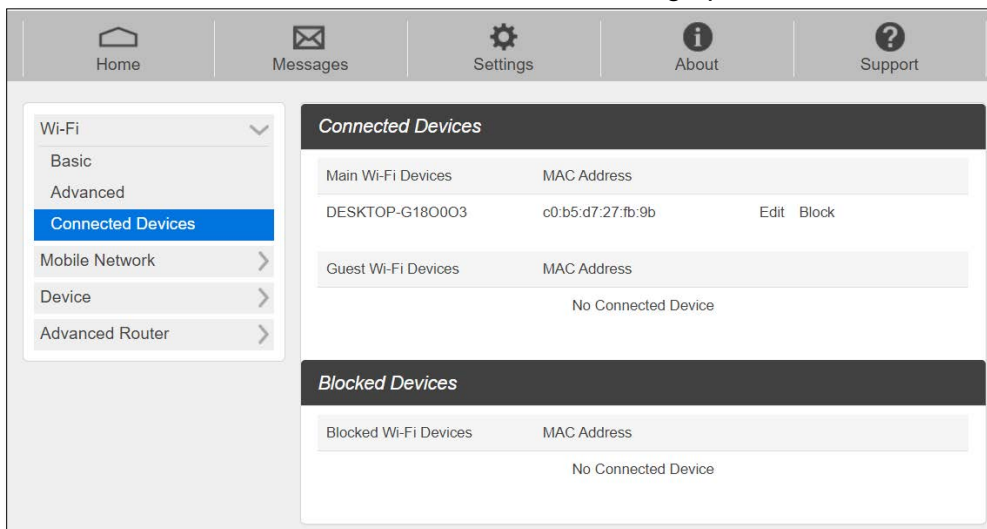

- Main Wi-Fi Devices – The hostname of the connected device as set on the connected device.
- MAC Address – The MAC address is a unique identifier for this connected device.

To Edit a Connected Device name:

1. Click on the **Edit**.
2. Update the name of the device and click **OK**.

To block connection:

1. Press **Block** on the device you want to block connection.
2. The device blocked will be listed on the Blocked Devices. The blocked devices will not be allowed to connect to your RG2100.
3. To unblock the device, press **Unblock**.

Mobile Network

Mobile Network menu help you to manage your mobile network settings.

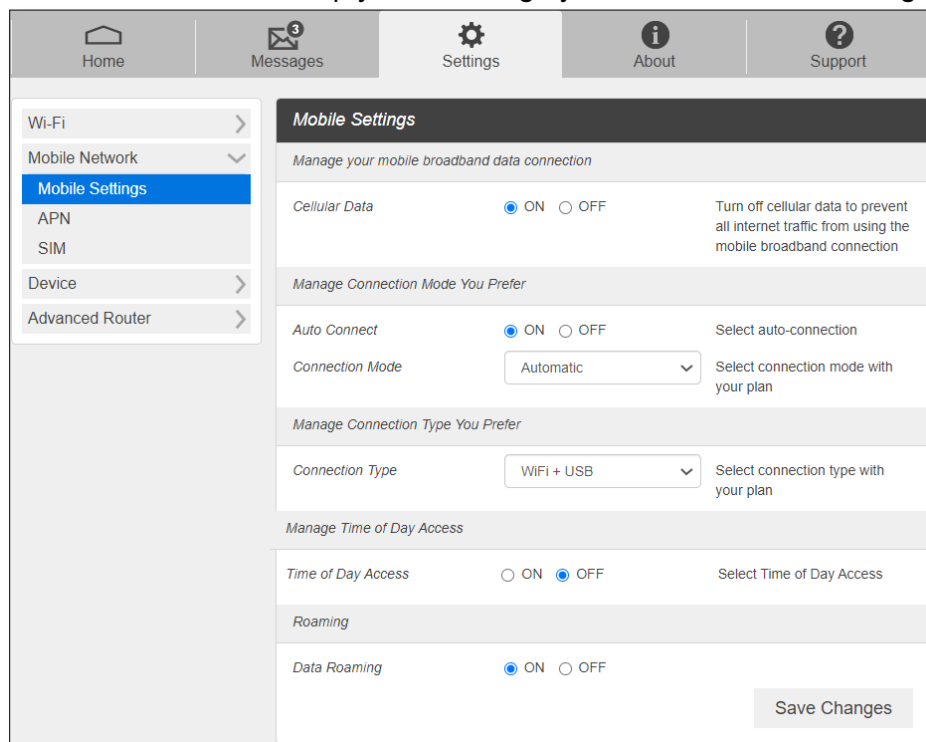

- Mobile Settings

- Cellular Data: Selecting **OFF** disconnects all data traffic to the network.
- Auto Connect: Select **ON** to make your device automatically connects to the network when it is powered on. If **OFF** is selected, you need to login the **Web Admin** home page to connect to the network manually every time you power on your mobile hotspot.
- Connection Mode: Select network type for your mobile hotspot to connect to.
- Connection Type: Select connection type between your connected devices and RG2100.
- Time of Day Access: You can set the time windows per day allowing data connection. Once set, your mobile hotspot will not allow data connection beside the time windows.
- Data Roaming: Turn Data Roaming **ON** or **OFF**.

CAUTION! Allowing roaming could result in additional service charges. Please contact your service provider for more details.

APN

APN menu displays current APN settings. You can add new APNs.

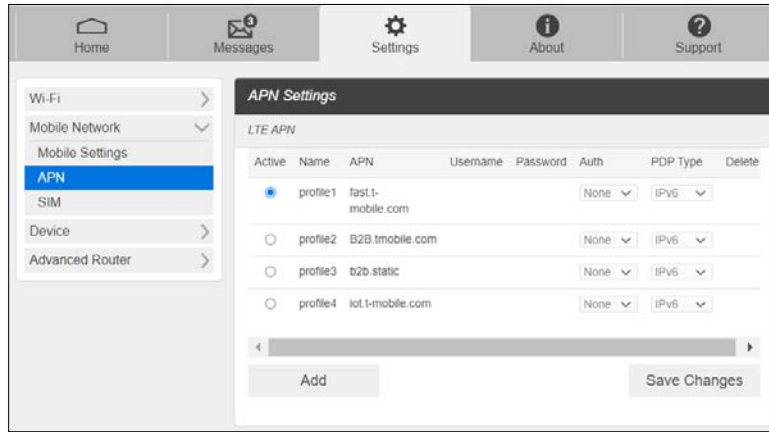

To add a new APN,

1. Click **Add** to access the following page.

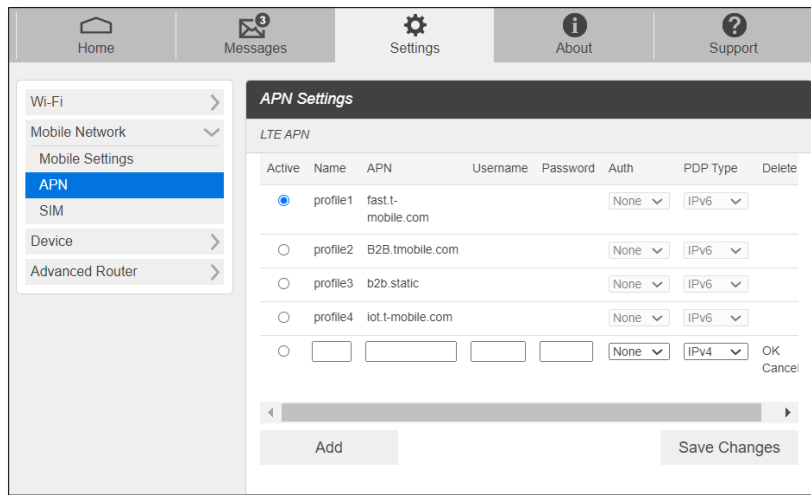

2. Enter the related parameters as described in the following table.

Parameters	Description
Name	Enter the APN profile name.
APN	Enter Access Point Name (APN) here. The Access Point Name (APN) is the name to set up a connection to the gateway between your service provider's cellular network and the public Internet.
Username	Username is used to obtain authentication from the ISP when the connection is established.

Password	Password is used to obtain authentication from the ISP when the connection is established.
Auth (Authentication)	Password Authentication Protocol (PAP) provides a simple method without encryption for the peer to establish its identity using a 2-way handshake. Challenge-Handshake Authentication Protocol (CHAP) is used to periodically verify the identity of the peer using a 3-way handshake.
PDP type	Select IP address type supported. IPv4, IPv6, IPv4v6

3. Click **Save Changes** to add the new APN.

Additional APN Options

- To select APN to use, click Active circle, then click **Save Changes**.
- To edit APN info, click **Edit**, change the settings, and then click **Save Changes**.
- To delete APN, click **Delete**.

CAUTION! Changing APN information could result in connection failure. Please contact your service provider before changing APN.

- **SIM** **SIM Pin Lock**

The **SIM** menu allows you to lock the SIM (Subscriber Identity Module) card in your device. The SIM card inside your device can be locked with a PIN code for additional security. If locked, the PIN code must be entered before the mobile hotspot can connect to the Internet whenever you power on your device. You can also change the SIM PIN.

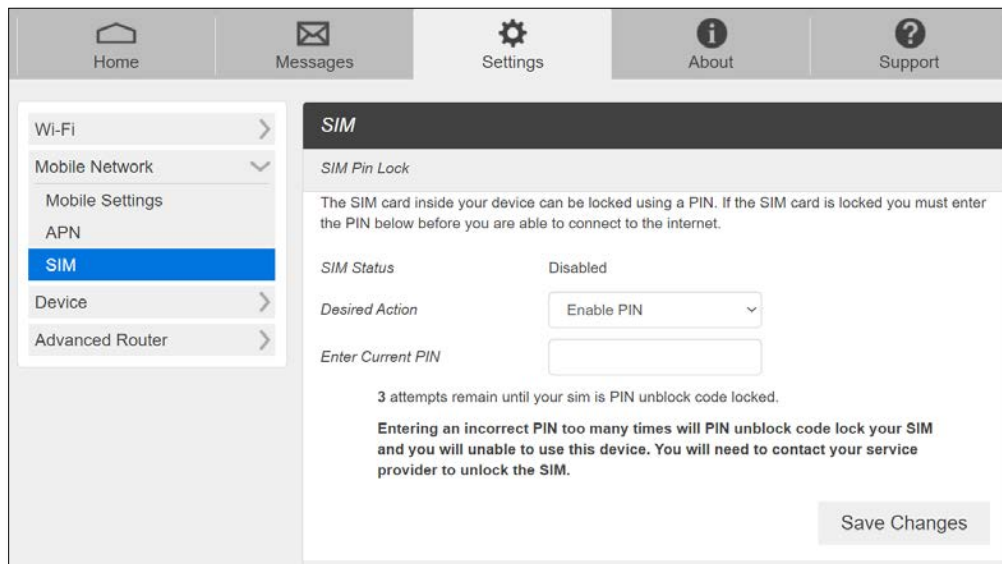

Enter the SIM PIN and press **Save Changes** to save your settings. The SIM Status will be changed to Enabled. Once the SIM PIN Lock is enabled, you need to enter SIM PIN to connect to the mobile broadband network each time you power on your RG2100 by logging in the **Web Admin** page.

NOTE: Contact your service provider for default SIM PIN code. If you enter the wrong SIM PIN three times, your SIM will be disabled permanently until you enter the PUK code from your service provider.

Carrier Unlock

Your RG2100 could be locked to the SIM from your wireless service provider only. To use other SIMs from other wireless service provider, you need to unlock the carrier lock. Contact your service provider for the carrier unlock code.

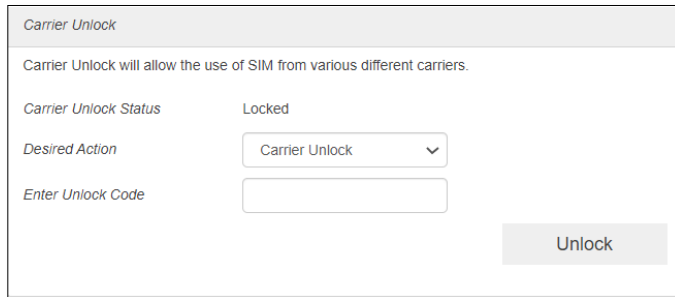

The image shows a 'Carrier Unlock' settings screen. At the top, it says 'Carrier Unlock will allow the use of SIM from various different carriers.' Below this, the 'Carrier Unlock Status' is 'Locked'. The 'Desired Action' is set to 'Carrier Unlock' in a dropdown menu. There is an empty text box for 'Enter Unlock Code'. An 'Unlock' button is located at the bottom right of the screen.

Device

- Preferences

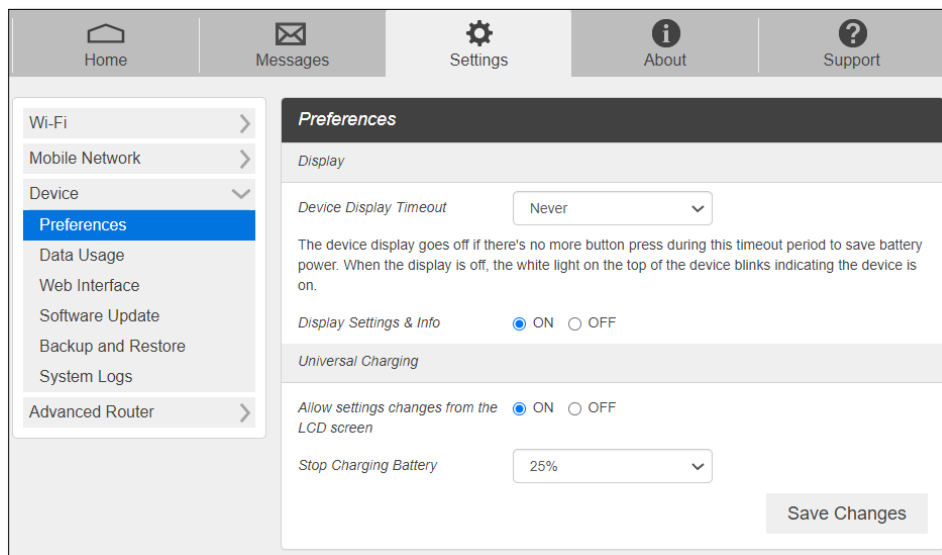

The image shows the 'Preferences' settings screen. The top navigation bar includes Home, Messages, Settings, About, and Support. The left sidebar lists various settings categories, with 'Preferences' selected. The main content area is titled 'Preferences' and includes the following settings:

- Display**
 - Device Display Timeout:** Set to 'Never'.
 - Display Settings & Info:** Set to 'ON'.
- Universal Charging**
 - Allow settings changes from the LCD screen:** Set to 'ON'.
 - Stop Charging Battery:** Set to '25%'.

A 'Save Changes' button is located at the bottom right of the screen.

- **Device Display Timeout:** Select a timeout time from the drop-down list. Your RG2100 display turns off after this timeout period to save battery power.
- **Display Settings & Info:** If **OFF** is selected, your RG2100 will not display **Web Admin** home page URL information on the device display.
- **Allow setting charges from the LCD screen (Universal Charging):** If **ON** is selected, you can charge your smartphone or other device using the RG2100 battery by connecting the USB cable provided.
- **Stop Charging Battery:** Select the battery level where your RG2100 battery to stop charging the other device connected via the USB cable provided.

- Data Usage

You can customize Data Usage Information settings here.

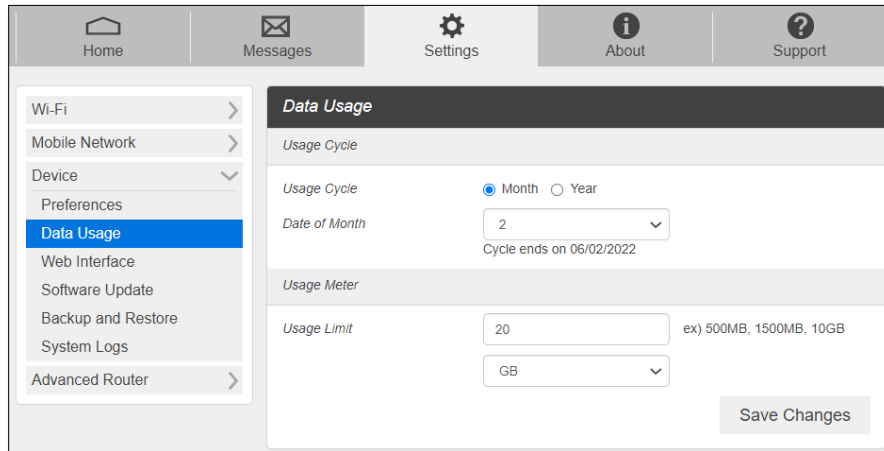

- Usage Cycle: Select if the data usage meter resets monthly or yearly.
- Data of Month (Year): Select the date when the data usage meter resets.
- Usage Limit: Enter data usage amount and unit. You will see alert message on your device display when data usage reaches 90% of the amount set here.

- Web Interface

You can change **Web Admin** home page login password.

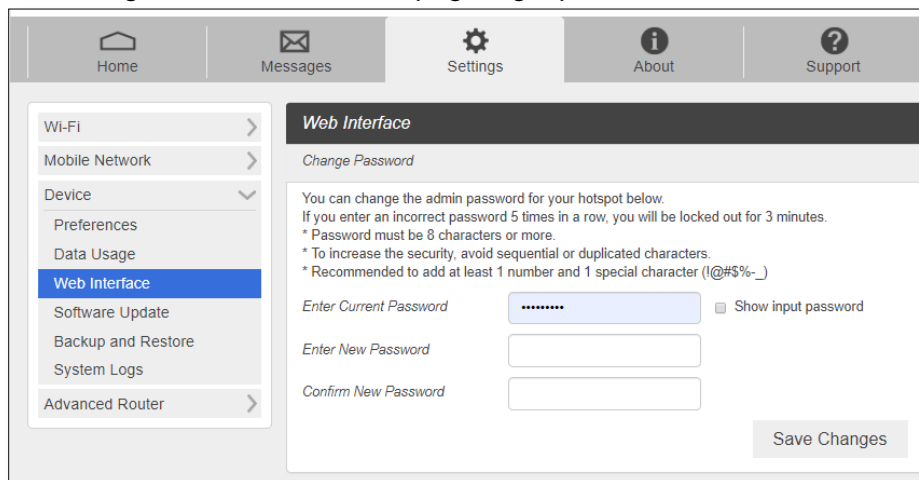

To change the password:

- Current Password: Enter the current password.
- New Password: Enter the new password.
- Confirm New Password: Enter the new password again.
- Click Save Changes to save your settings.

- Software Update

You can find the current software version and check for a new update available.

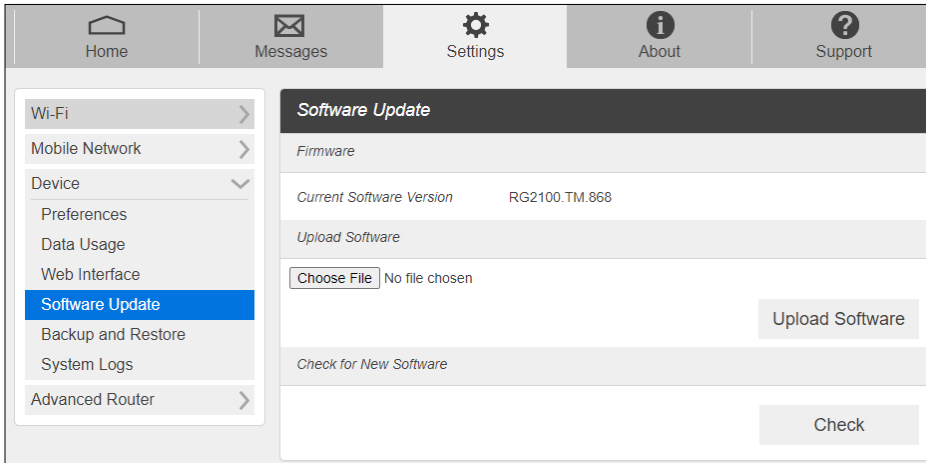

Manual Update: In case you have a new software file provided by your operator, select the file by pressing **Choose File**, then press **Upload Software** to update your device software.

Automatic Update: Click **Check** button. Message windows will pop up and guide you through the update process.

- Backup and Restore

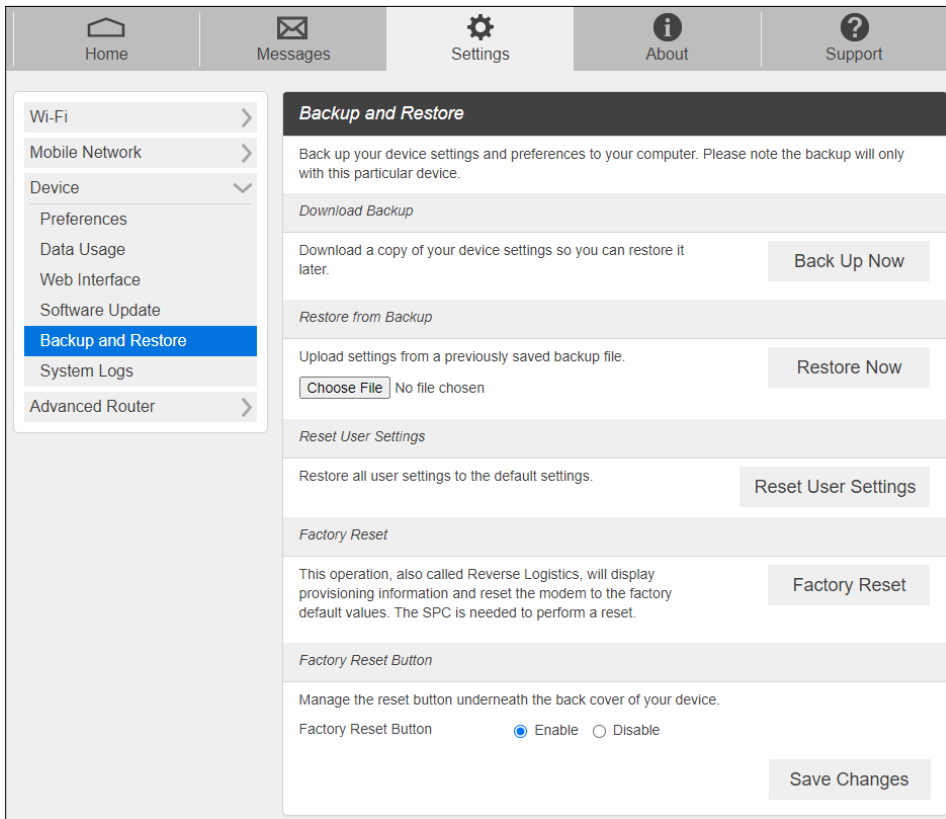

To back up your device settings into a file to your computer, click **Back Up Now** button.
The backup setting file (hotspot_cfg.bin) will be created on the downloads folder of your device.

To restore the device setting from the backup file you made, follow the steps below:
a. Click **Choose File** and select the backup file you saved.
b. Click **Restore now**. Your mobile hotspot will restart.

To reset user settings to the factory default settings,
a. Click **Reset User Settings**.
b. Click **OK** to confirm the command.

To restore all your device settings to its factory default settings, follow the steps below:
a. Click **Factory Reset**.
b. Click **OK** to confirm the command.

Factory Reset Button: you can disable the physical factory reset button underneath the battery cover. If **Disable** is selected, pressing the button will not perform factory reset.

Advanced Router

Configure LAN, Firewall, and other Router settings.

- LAN Settings

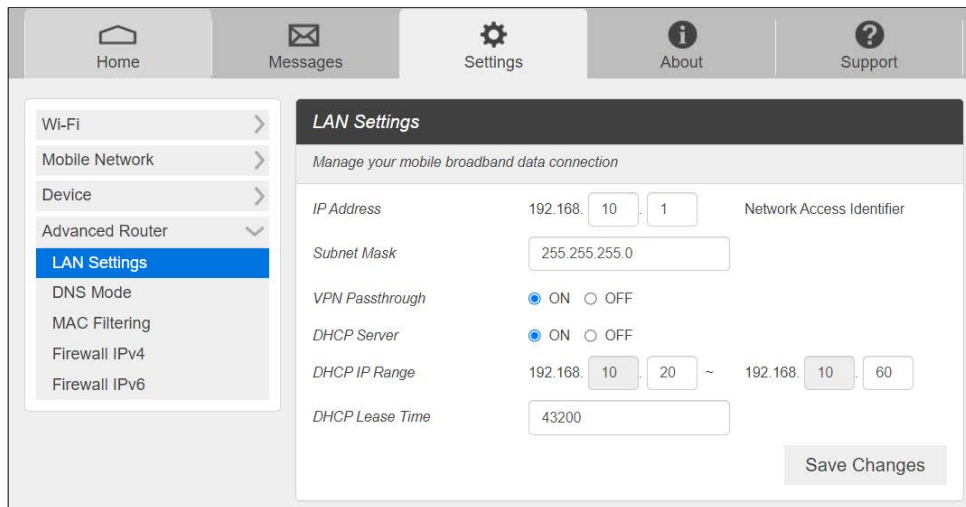

- **IP address** – The IP address for your Mobile Hotspot **Web Admin** page. This is also a default gateway IP of your device.

- **Subnet mask** – The Subnet mask network setting for your mobile hotspot. The default value 255.255.255.0 is standard for small (class “C”) networks.
- **VPN Passthrough** – When turned **ON**, this feature allows VPN clients on your connected device to connect through your mobile hotspot to remote VPN servers.
- **DHCP (Dynamic Host Configuration Protocol) server** – The **DHCP server** is **ON** by default. When turned **ON**, your mobile hotspot automatically assigns local IPs to the devices connected to your mobile hotspot. When turned **OFF**, you will need to set it up manually from the device you want to connect to your mobile hotspot.
- **DHCP IP Range** – Defines the local IP range that DHCP server assigns to connected devices.
- **DHCP Lease Time** - The period between when your connected device obtained its IP address from your mobile hotspot and the time when it expires. When the **DHCP lease time** expires, your connected device automatically releases IP address and asks your mobile hotspot to assign a new one.

- **DNS Mode**

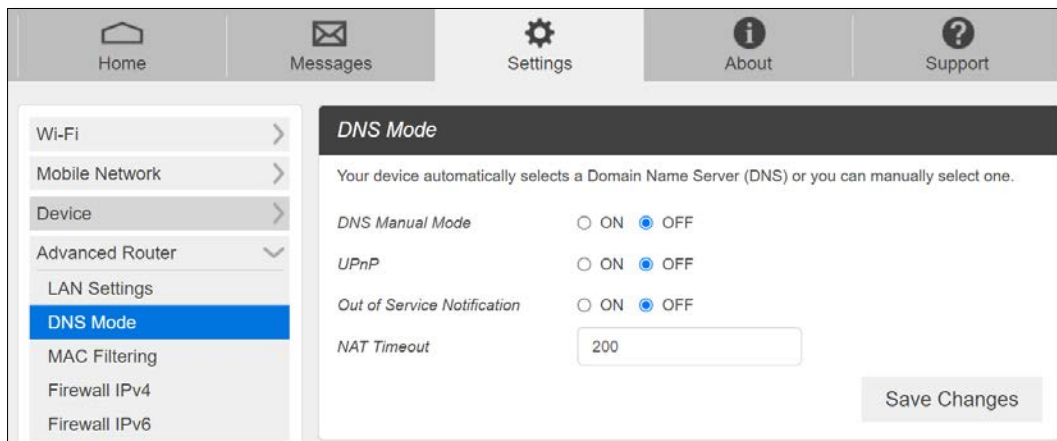

- **DNS Manual Mode-** Your mobile hotspot uses Domain Name Servers (DNS) assigned by your network by default. The **DNS Manual Mode** option allows you to use your own DNS service if you have.

To manually set a Domain Name Server:

1. Click the **ON** button to enable **DNS Manual Mode**.
2. Enter the IP address of the first DNS in the **DNS 1 IP address** field.
3. Enter the IP address of the second DNS in the **DNS 2 IP address** field.
4. Click **Save Changes** button.

- **UPnP** - Universal Plug and Play (UPnP) is a network protocol that allows compliant devices to automatically set port forwarding rules for themselves. These devices can be personal computers, printers, security cameras, game consoles or mobile devices that communicate with each other and share data over your network
- **Out of Service Notification:** Notify when DNS service is not working

- **NAT Timeout** - NAT session timeout is the length of time that the router will keep that connection even if it is inactive. After that, the router will remove the entry, and stop accepting the incoming traffic.

- **MAC Filtering**

The MAC filtering allows only selected devices to access your mobile hotspot Wi-Fi network. By default, MAC filtering is turned **OFF**.

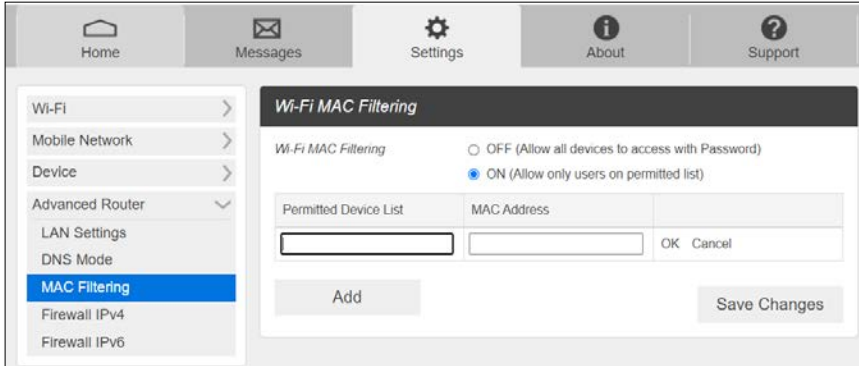

To enable MAC Filtering,

1. Select **ON**.
2. Press **Add** to add a line to enter device name and MAC address, then click **OK**.
When entering MAC addresses, use “:” as the separators (for example, c2:b5:d7:27:fb:9b).
To add more, press **Add** to add another line.
3. When completed adding devices, press **Save Changes**.

NOTE: If MAC filtering is on and at least one device is listed, only the listed devices can access your RG2100 Wi-Fi network. The MAC filtering has no effect on devices connected via USB connection.

- **Firewall IPv4**

You can set up firewall rules to protect your network from virus and malicious activity on the Internet.

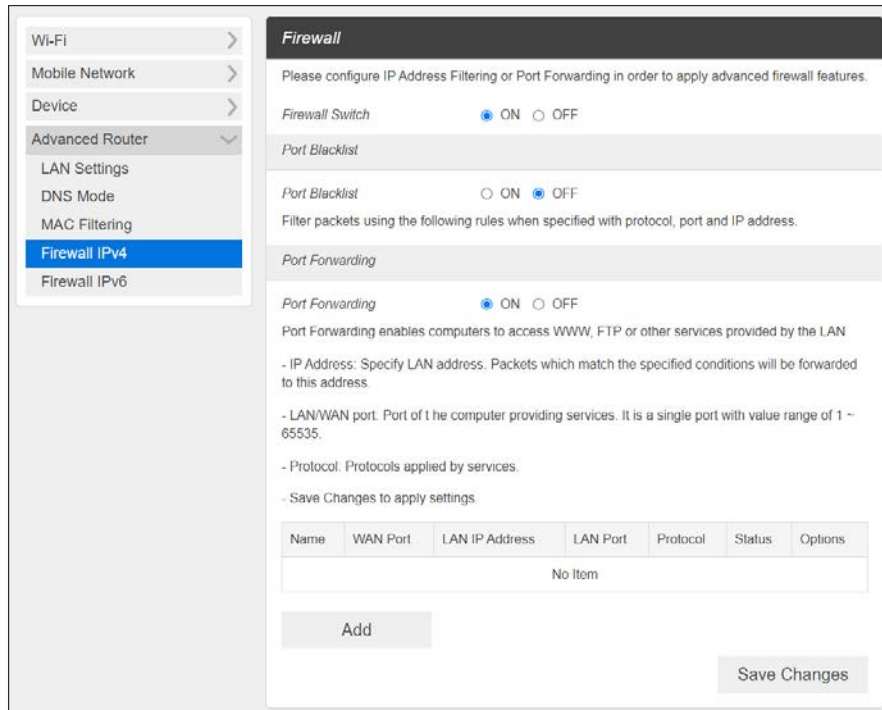

- **Firewall Switch** – To set up Port Blacklist or Port Forwarding, turn Firewall Switch **ON**. If Firewall Switch is **OFF**, both Port Blacklist and Port Forwarding settings are not active.

- **Port Blacklist** – You can block outbound forward packet by setting up a rule in the blacklist. To set up the rule,
 1. Turn **ON** Port Blacklist.
 2. Press **Add** to create a line to setup a rule.
 3. Enter the name of the rule you want to set up.
 4. Enter IP address of the site you want to restrict outbound forward packet.
 5. Enter Port number of the outbound forward packet.
 6. Select Protocol and Status **ON/OFF**: **ON** means the rule is in active. **OFF** means the rule is not active.
 7. Press **OK** to complete set up, then press **Save Changes**.

- **Port Forwarding** – You can allow inbound packet for specific port number by setting up port forwarding rule. To set up Port Forwarding,
 1. Turn **ON** Port Forwarding.
 2. Press **Add** to create a line to set up a rule.
 3. Enter the name of the rule you want to set up.
 4. Enter WAN port number of allowed inbound forward packet.
 5. Enter LAN IP address your connected device that is assigned by your mobile hotspot.
 6. Enter LAN port number of allowed inbound forward packet.
 7. Select Protocol and Status **ON/OFF**: **ON** means the rule is in active. **OFF** means the rule is not active.

8. Press **OK** to complete set up, then press **Save Changes**.

- **Firewall IPv6**

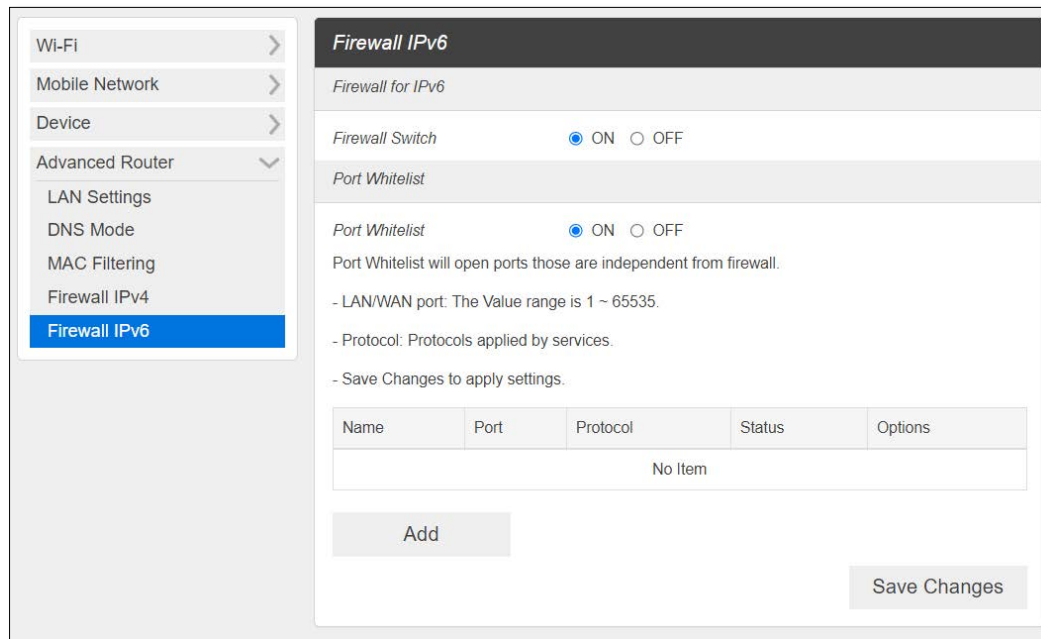

- **Firewall Switch** – To set up Port Whitelist, turn Firewall Switch **ON**. If Firewall Switch is **OFF**, Port Whitelist settings is not active.
- **Port Whitelist** – You can allow inbound forward packet of specific port number by setting up Port Whitelist. To set up Port Whitelist,
 1. Turn **ON** Port Whitelist.
 2. Press **Add** to create a line to set up a rule.
 3. Enter the name of the rule you want to create.
 4. Enter the port number you want to allow inbound forward packet.
 5. Select Protocol and Status **ON/OFF**: **ON** means the rule is in active. **OFF** means the rule is not active.
 6. Press **OK** to complete set up, then press **Save Changes**.

About

View your device's connection information, firmware information, WWAN information, Wi-Fi details and other information.

The screenshot displays the 'About' settings page with the following information:

- Account**
 - My Number: 14254997830
 - ICCID: 8901260171789460370F
 - IMSI: 310260178946037
 - IMEI: 358563790000157
- Device**
 - Model: RG2100
 - Manager: mobile.hotspot
 - Hardware Revision: P1
 - Power State: Online
 - Current Voltage: 3.982V
 - Battery Charge Level: 85%
 - Battery Status: Normal
- Wi-Fi Details**
 - Wi-Fi Name: RG2100 DK M
 - Wi-Fi Password: 12345678
 - MAC Address: F4:63:49:C9:C2:58
 - Encryption: WPA2 AES
 - Wi-Fi Devices: 1
 - Max Wi-Fi Devices: 10
 - Broadcast Network Name: Show
- Firmware**
 - Software Version: RG2100.TM.868
 - Modem Version: RG2100.TM.M868
- WWAN Info**
 - IP Address: 192.0.0.2, 2607:fb90:73aa:5d33:f88a:29d9:2820:d136
 - Lifetime Transferred: 6.11 GB

A 'Save to File' button is located below the WWAN Info section.

Debug Info
View detailed diagnostic information about your device.
Debug

Support

Obtain support information from the **Web Admin** page Support Tab.

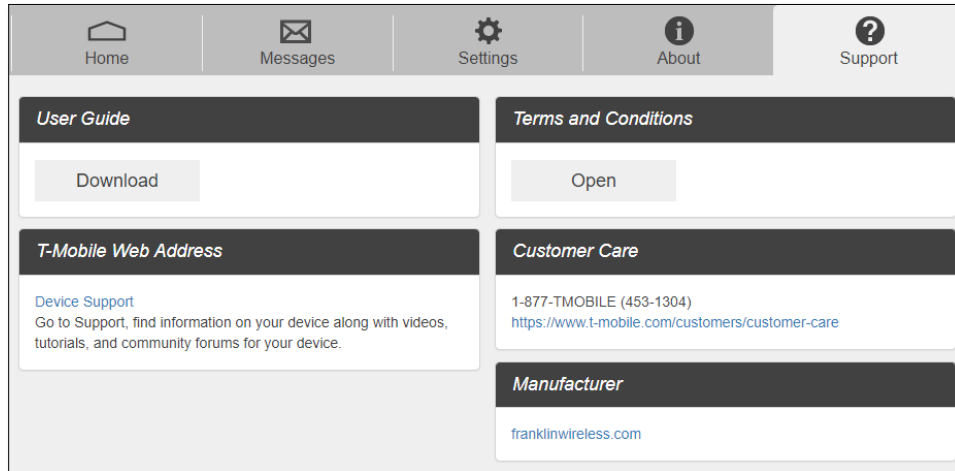

4

Troubleshooting

Overview
First Steps
Common Problems and Solutions

Overview

The following tips can help solve many common problems encountered while using your Mobile Hotspot, RG2100.

First Steps

- 1 Make sure you are using your RG2100 in the correct geographic region (within coverage of your service provider).
- 2 Ensure that your wireless coverage extends to your current location by using the interactive Wireless Carrier's coverage map tool.
- 3 Ensure that you have an active service plan.
- 4 Restarting your computer and your RG2100 can resolve many issues.

IMPORTANT! Before contacting customer care, be sure to restart both your RG2100 and any host devices that are currently connected to your RG2100.

Common Problems and Solutions

RG2100 is just powered off without pressing the Power/Menu button. Why?

This may occur under battery depletion or overheating from excessive usage for a long time. To restore power, manually press and hold the power button to turn on your RG2100. If the battery is depleted, charge the battery with the AC charger provided.

IMPORTANT! If the power button will not start your RG2100, please open the battery cover, take out the battery and re-install the battery after 5 seconds. Put the battery cover back and turn on the RG2100 by pressing the power button.

How do I perform Factory Reset?

Using Web Admin Home page: Connect to your RG2100 and then open **Web Admin** home page (<http://mobile.hotspot> or <http://192.168.0.1>). Select **Settings > Device > Backup and Restore** and Click **Factory Reset**.

Using Mobile Hotspot Device Menu: Select **Settings** on the device display, then go to Factory Reset menu. Select **OK** to perform Factory Reset.

Using the Factory Reset Button on the device: Remove the battery cover. Make sure the battery is installed and your RG2100 is powered on. Press down the reset button for 3 seconds and release. Then, your RG2100 will perform the reset and restart automatically.

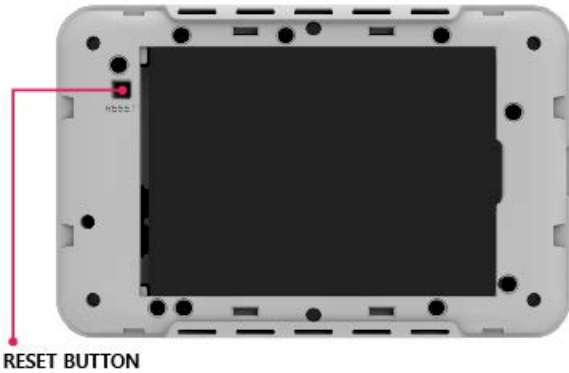

I cannot connect to Wi-Fi after changing Wi-Fi password.

Your Wi-Fi devices save the previously used Wi-Fi names associated with the passwords used to access the Wi-Fi name. When you change the Wi-Fi password only for your RG2100 and keep the same Wi-Fi Name, the devices try to connect to your RG2100 using the Wi-Fi name and previous Wi-Fi password saved, causing Wi-Fi authentication error. Perform “forget” first on the Wi-Fi name from your host devices.

I cannot access the Web Admin, <http://192.168.0.1>

Ensure that Wi-Fi connection is enabled on your device and that you have selected the correct Wi-Fi name (SSID) for your RG2100 connection. Also, make certain that you are entering the correct full URL address as <http://192.168.0.1> or <http://mobile.hotspot>.

If you changed the LAN IP settings from the **Web Admin, Settings > Advanced Router > LAN Settings** before, you need to use the IP address you changed to access the **Web Admin** page.

I cannot log into Web Admin, <http://mobile.hotspot> or <http://192.168.0.1>

Ensure that you are entering the correct **Web Admin** password to log in. The default **Web Admin** login password is “admin” unless you have previously changed. If you have forgotten your password, perform Factory Rest on your device (see How do I perform Factory Reset?).

5

Regulatory Information

Regulatory Statements
Safety Hazards

Regulatory Statements

FCC Equipment Authorization ID: XHG-RG2100

This device complies with Part 15 of the FCC Rules. Operation is subject to the following two conditions: (1) this device may not cause harmful interference, and (2) this device must accept any interference received, including interference that may cause undesired operation.

SAR Information

The exposure standard for your device uses a unit of measurement called the Specific Absorption Rate (“SAR”).

SAR is the unit of measurement for the amount of RF energy absorbed by the body when using a mobile device. Although the SAR is determined at the highest certified power level, the actual SAR value of the device while in operation can be well below the level reported to the FCC. This is due to a variety of factors including its proximity to a base station, the design of the device and other factors. What is important to remember is that each device meets strict Federal Government guidelines. Variations in SARs do not represent a variation in safety. All devices must meet the federal standard, which incorporates a substantial margin of safety. SAR values at or below the federal standard of 1.6 watts/kg (W/kg) are considered safe for use by the public. This product meets current FCC Radio Frequency Exposure Guidelines.

Additional details at FCC website:

www.fcc.gov/oet/ea

Body-Worn Operation

Please note this important safety information regarding radio frequency (RF) radiation exposure and near-body operation. To ensure compliance with RF exposure guidelines, the device must be used at least 10 mm from your body. Failure to observe this warning could result in RF exposure exceeding the applicable guideline limits.

This equipment has been tested and found to comply with the limits for a Class B digital device, pursuant to part 15 of the FCC Rules. These limits are designed to provide reasonable protection against harmful interference in a residential installation.

This equipment generates, uses, and can radiate radio frequency energy and, if not installed and used in accordance with the instructions, may cause harmful interference to radio communications. However, there is no guarantee that interference will not occur in a particular installation. If this equipment does cause harmful interference to radio or television reception, which can be determined by turning the equipment off and on, the user is encouraged to try to correct the interference by one or more of the following measures:

- Reorient or relocate the receiving antenna.
- Increase the separation between the equipment and receiver.
- Connect the equipment into an outlet on a circuit different from that to which the receiver is connected.
- Consult the dealer or an experienced radio/TV technician for help.

FCC CAUTION: Any changes or modification not expressly approved by the party responsible for compliance could void the user's authority to operate this equipment.

NOTE: The Radio Frequency (RF) emitter installed in your modem must not be located or operated in conjunction with any other antenna or transmitter, unless specifically authorized by Franklin Wireless.

Safety Hazards

Follow Safety Guidelines

Always follow the applicable rules and regulations in the area in which you are using your device. Turn your device off in areas where its use is not allowed or when its use may cause interference or other problems.

Electronic Devices

Most modern electronic equipment is shielded from radio frequency (RF) signals. However, inadequately shielded electronic equipment may be affected by the RF signals generated by your device.

Medical and Life Support Equipment

Do not use your device in healthcare facilities or where medical life support equipment is located as such equipment could be affected by your device's external RF signals.

Pacemakers

- The Health Industry Manufacturers Association recommends that a minimum separation of six inches must be maintained between a device and a pacemaker in order to avoid potential interference with the pacemaker. These recommendations are consistent with the independent research by and recommendations of Wireless Technology Research. Persons with pacemakers should always follow these guidelines:
- Always keep the device at least six inches away from a pacemaker when the device is turned on.
- Place your device on the opposite side of your body where your pacemaker is implanted in order to add extra distance between the pacemaker and your device.
- Avoid placing a device that is on next to a pacemaker (e.g., do not carry your device in a shirt or jacket pocket that is located directly over the pacemaker).
- If you are concerned or suspect for any reason that interference is taking place with your pacemaker, turn your device OFF immediately.

Hearing Devices

When some wireless devices are used with certain hearing devices (including hearing aids and cochlear implants) users may detect a noise which may interfere with the effectiveness of the hearing device.

Use of Your Device while Operating a Vehicle

Please consult the manufacturer of any electronic equipment that has been installed in your vehicle as RF signals may affect electronic systems in motor vehicles.

Please do not operate your device while driving a vehicle. This may cause a severe distraction, and, in some areas, it is against the law.

Use of Your Device on an Aircraft

Using your device during flight may violate FAA regulations. Because your device may interfere with onboard electronic equipment, always follow the instructions of the airline personnel, and turn your device OFF when instructed to do so.

Blasting Areas

In order to avoid interfering with blasting operations, your device should be turned OFF when in a blasting area or in an area with posted signs indicating that people in the area must turn off two-way radios. Please obey all signs and instructions when you are in and around a blasting area.

Proper Battery & Adapter Use and Disposal

- Do not disassemble or open crush, bend or deform, puncture or shred.
- Do not modify or remanufacture, attempt to insert foreign objects into the battery, immerse or expose to water or other liquids, expose to fire, explosion, or another hazard.
- Only use the battery for the system for which it is specified.
- Only use the battery with a charging system that has been qualified with the system per CTIA Certification Requirements for Battery System Compliance to IEEE 1725. Use of an unqualified battery or charger may present a risk of fire, explosion, leakage, or another hazard.
- Do not short circuit a battery or allow metallic conductive objects to contact battery terminals.
- Replace the battery only with another battery that has been qualified with the system per this standard, IEEE-Std-1725. Use of an unqualified battery may present a risk of fire, explosion, leakage, or another hazard. Only authorized service providers shall replace the battery.
- Promptly dispose of used batteries in accordance with local regulations.
- Battery usage by children should be supervised.
- Avoid dropping the battery. If the battery is dropped, especially on a hard surface, and the user suspects damage, take it to a service center for inspection.
- Improper battery use may result in a fire, explosion, or another hazard.
- The host device shall only be connected to CTIA certified adapters, products that bear the USB-IF logo or products that have completed the USB-IF compliance program.

Document Revision History

Revision: Rev. 0.1
Date: May 10, 2022

6

Glossary

Glossary

Term	Definition
5G NR	5 th Generation New Radio
LTE	Long-Term Evolution
802.11(b/g/n/ac/ax)	A set of WLAN communication standards in the 2.4GHz frequency band and 5GHz frequency band.
Bps	Bits per second
Broadband	High capacity, high-speed transmission channel with a wider bandwidth than conventional modem lines.
DHCP	Dynamic Host Configuration Protocol
DHCP Server	A server or service with a server that assigns IP addresses.
DNS	Domain Name System
Firmware	A computer program embedded in electronic devices. Firmware usually contains operating code for the device.
GB	Gigabyte
Hotspot	A Wi-Fi (802.11b/g/n/ac) access point or the area covered by an access point.
HTTP	Hyper Text Transfer Protocol
IMEI	International Mobile Equipment Identity
IMSI	International Mobile Subscriber Identity
IP	Internet Protocol
IP Type	The type of service provided over a network.
IP Address	The address of a device attached to an IP network.
ISP	Internet Service Provider
Kbps	Kilobits per second
LAN	Local Area Network
MAC Address	Media Access Control address
Mbps	Megabits per second
Network Operator	The vendor who provides your wireless access.
Port	A virtual data connection used by a program to exchange data.
Port Forwarding	A process that allows remote devices to connect to a specific computer within a private LAN.
Port Number	A 16-bit number used by the TCP and UDP protocols to direct traffic.
Protocol	A standard that allows connection, communication, and data transfer between computing endpoints.
Proxy	A firewall mechanism that replaces the IP address of a host on the internal (protected) network with its own IP address.
Router	A device that directs traffic from one network to another.
SIM	Subscriber Identification Module
SSID	Service Set Identifier
TCP/IP	Transmission Control Protocol/Internet Protocol
USB	Universal Serial Bus
VPN	Virtual Private Network
WLAN	Wireless Local Area Network
WWAN	Wireless Wide Area Network